

| Bar  | Qty | Bar      | Total | Bar  | Bar  | A | B | C | D | E | F | G | H | J | K | O | R |
|------|-----|----------|-------|------|------|---|---|---|---|---|---|---|---|---|---|---|---|
| 1002 | 6   | #11 210" | 3     | 1002 | 1002 |   |   |   |   |   |   |   |   |   |   |   |   |
| 1003 | 6   | #11 200" | 3     | 1003 | 1003 |   |   |   |   |   |   |   |   |   |   |   |   |
| 1004 | 6   | #10 280" | 3     | 1004 | 1004 |   |   |   |   |   |   |   |   |   |   |   |   |
| 1005 | 6   | #10 290" | 3     | 1005 | 1005 |   |   |   |   |   |   |   |   |   |   |   |   |
| 1006 | 6   | #10 210" | 2     | 1006 | 1006 |   |   |   |   |   |   |   |   |   |   |   |   |
| 1007 | 6   | #10 200" | 2     | 1007 | 1007 |   |   |   |   |   |   |   |   |   |   |   |   |
| 1008 | 6   | #10 200" | 2     | 1008 | 1008 |   |   |   |   |   |   |   |   |   |   |   |   |
| 1009 | 6   | #10 210" | 2     | 1009 | 1009 |   |   |   |   |   |   |   |   |   |   |   |   |
| 1010 | 6   | #10 200" | 2     | 1010 | 1010 |   |   |   |   |   |   |   |   |   |   |   |   |
| 1011 | 6   | #10 200" | 2     | 1011 | 1011 |   |   |   |   |   |   |   |   |   |   |   |   |
| 1012 | 6   | #10 210" | 2     | 1012 | 1012 |   |   |   |   |   |   |   |   |   |   |   |   |
| 1013 | 6   | #10 210" | 2     | 1013 | 1013 |   |   |   |   |   |   |   |   |   |   |   |   |
| 1014 | 6   | #10 210" | 2     | 1014 | 1014 |   |   |   |   |   |   |   |   |   |   |   |   |
| 1015 | 6   | #10 210" | 2     | 1015 | 1015 |   |   |   |   |   |   |   |   |   |   |   |   |
| 1016 | 6   | #10 210" | 2     | 1016 | 1016 |   |   |   |   |   |   |   |   |   |   |   |   |
| 1017 | 6   | #10 210" | 2     | 1017 | 1017 |   |   |   |   |   |   |   |   |   |   |   |   |
| 1018 | 6   | #10 210" | 2     | 1018 | 1018 |   |   |   |   |   |   |   |   |   |   |   |   |
| 1019 | 6   | #10 210" | 2     | 1019 | 1019 |   |   |   |   |   |   |   |   |   |   |   |   |
| 1020 | 6   | #10 210" | 2     | 1020 | 1020 |   |   |   |   |   |   |   |   |   |   |   |   |
| 1021 | 6   | #10 210" | 2     | 1021 | 1021 |   |   |   |   |   |   |   |   |   |   |   |   |
| 1022 | 6   | #10 210" | 2     | 1022 | 1022 |   |   |   |   |   |   |   |   |   |   |   |   |
| 1023 | 6   | #10 210" | 2     | 1023 | 1023 |   |   |   |   |   |   |   |   |   |   |   |   |
| 1024 | 6   | #10 210" | 2     | 1024 | 1024 |   |   |   |   |   |   |   |   |   |   |   |   |
| 1025 | 6   | #10 210" | 2     | 1025 | 1025 |   |   |   |   |   |   |   |   |   |   |   |   |
| 1026 | 6   | #10 210" | 2     | 1026 | 1026 |   |   |   |   |   |   |   |   |   |   |   |   |
| 1027 | 6   | #10 210" | 2     | 1027 | 1027 |   |   |   |   |   |   |   |   |   |   |   |   |
| 1028 | 6   | #10 210" | 2     | 1028 | 1028 |   |   |   |   |   |   |   |   |   |   |   |   |
| 1029 | 6   | #10 210" | 2     | 1029 | 1029 |   |   |   |   |   |   |   |   |   |   |   |   |
| 1030 | 6   | #10 210" | 2     | 1030 | 1030 |   |   |   |   |   |   |   |   |   |   |   |   |
| 1031 | 6   | #10 210" | 2     | 1031 | 1031 |   |   |   |   |   |   |   |   |   |   |   |   |
| 1032 | 6   | #10 210" | 2     | 1032 | 1032 |   |   |   |   |   |   |   |   |   |   |   |   |
| 1033 | 6   | #10 210" | 2     | 1033 | 1033 |   |   |   |   |   |   |   |   |   |   |   |   |
| 1034 | 6   | #10 210" | 2     | 1034 | 1034 |   |   |   |   |   |   |   |   |   |   |   |   |
| 1035 | 6   | #10 210" | 2     | 1035 | 1035 |   |   |   |   |   |   |   |   |   |   |   |   |
| 1036 | 6   | #10 210" | 2     | 1036 | 1036 |   |   |   |   |   |   |   |   |   |   |   |   |
| 1037 | 6   | #10 210" | 2     | 1037 | 1037 |   |   |   |   |   |   |   |   |   |   |   |   |
| 1038 | 6   | #10 210" | 2     | 1038 | 1038 |   |   |   |   |   |   |   |   |   |   |   |   |
| 1039 | 6   | #10 210" | 2     | 1039 | 1039 |   |   |   |   |   |   |   |   |   |   |   |   |
| 1040 | 6   | #10 210" | 2     | 1040 | 1040 |   |   |   |   |   |   |   |   |   |   |   |   |
| 1041 | 6   | #10 210" | 2     | 1041 | 1041 |   |   |   |   |   |   |   |   |   |   |   |   |
| 1042 | 6   | #10 210" | 2     | 1042 | 1042 |   |   |   |   |   |   |   |   |   |   |   |   |
| 1043 | 6   | #10 210" | 2     | 1043 | 1043 |   |   |   |   |   |   |   |   |   |   |   |   |
| 1044 | 6   | #10 210" | 2     | 1044 | 1044 |   |   |   |   |   |   |   |   |   |   |   |   |
| 1045 | 6   | #10 210" | 2     | 1045 | 1045 |   |   |   |   |   |   |   |   |   |   |   |   |
| 1046 | 6   | #10 210" | 2     | 1046 | 1046 |   |   |   |   |   |   |   |   |   |   |   |   |
| 1047 | 6   | #10 210" | 2     | 1047 | 1047 |   |   |   |   |   |   |   |   |   |   |   |   |
| 1048 | 6   | #10 210" | 2     | 1048 | 1048 |   |   |   |   |   |   |   |   |   |   |   |   |
| 1049 | 6   | #10 210" | 2     | 1049 | 1049 |   |   |   |   |   |   |   |   |   |   |   |   |
| 1050 | 6   | #10 210" | 2     | 1050 | 1050 |   |   |   |   |   |   |   |   |   |   |   |   |

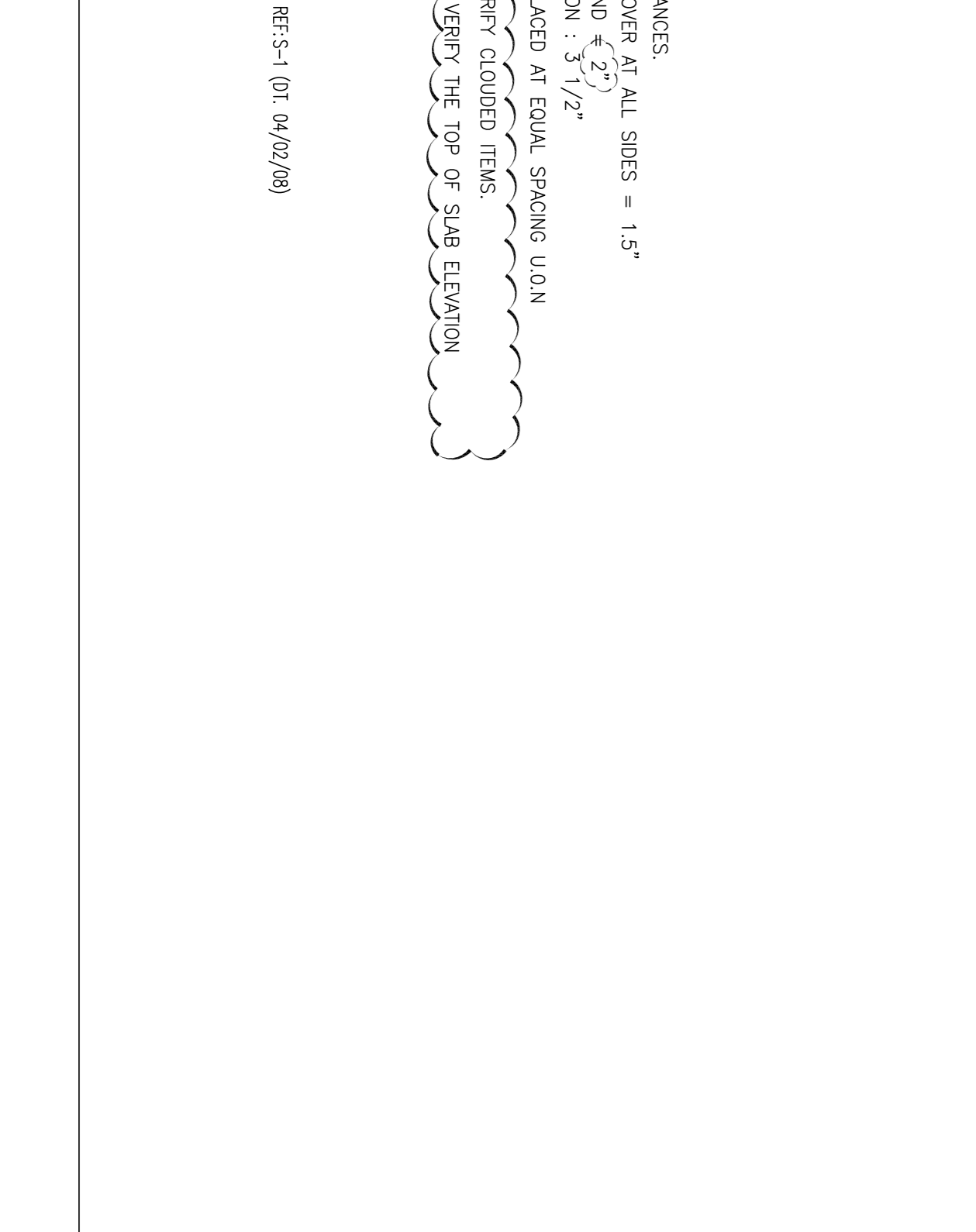
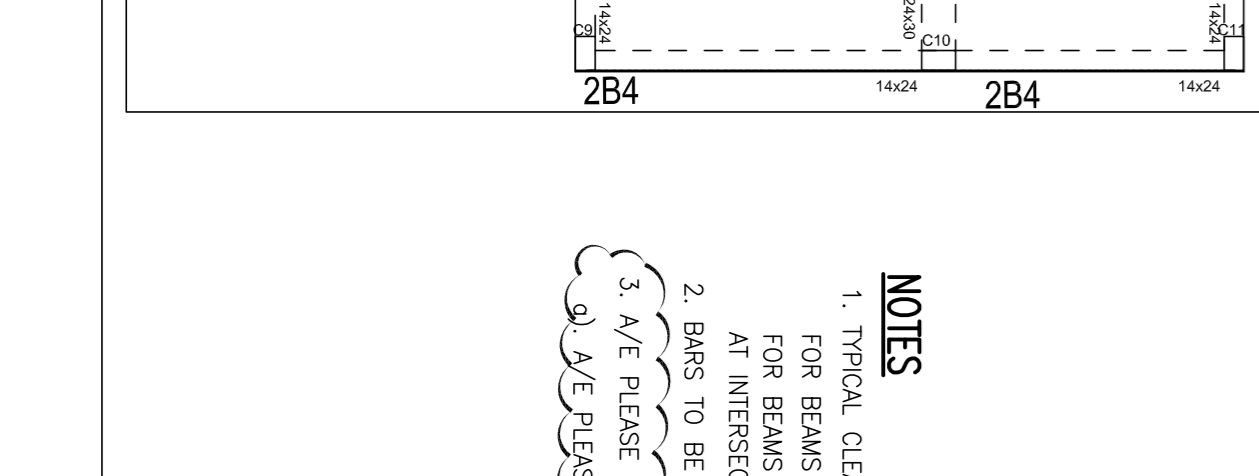
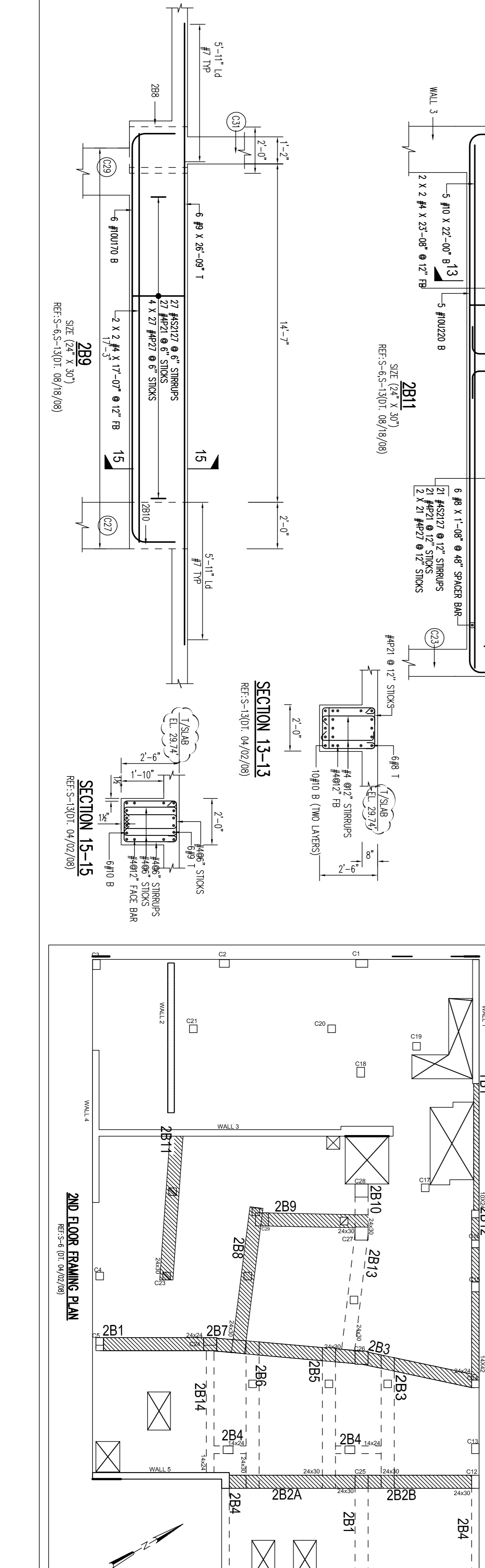
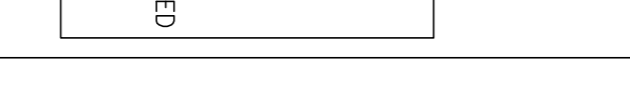
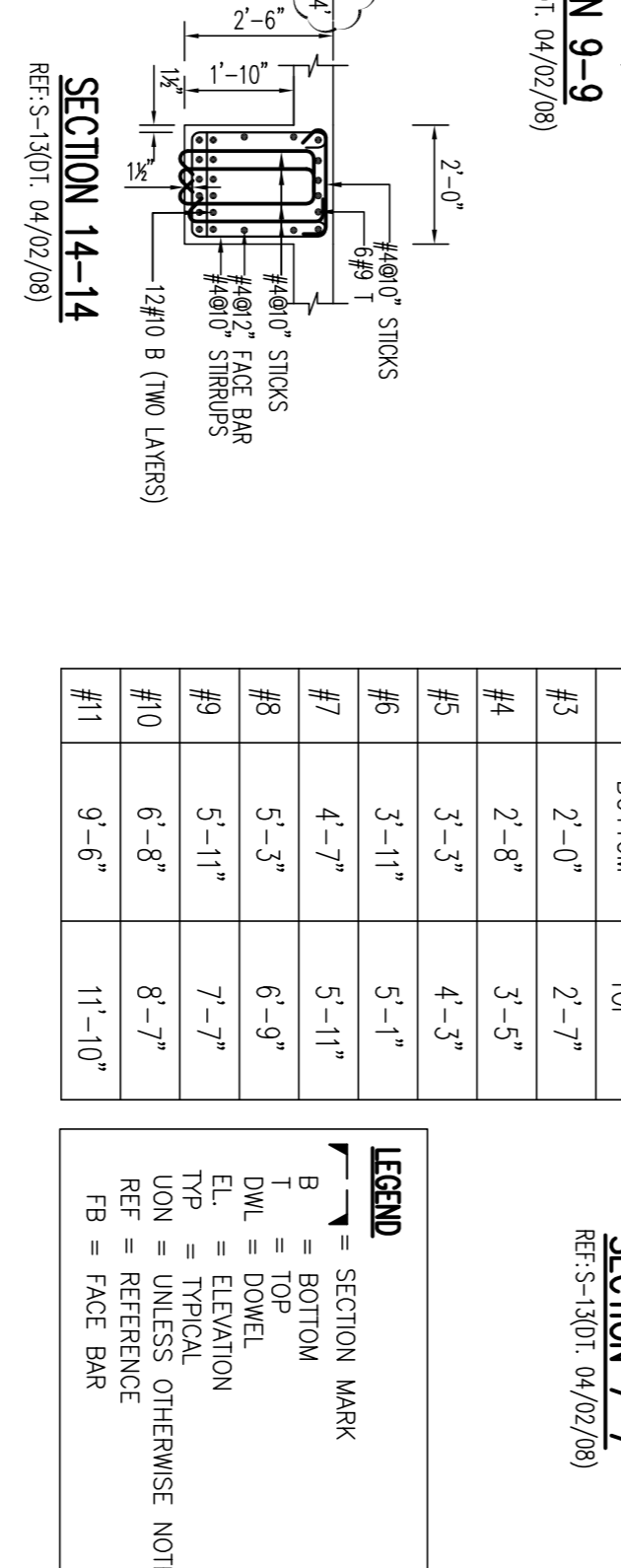
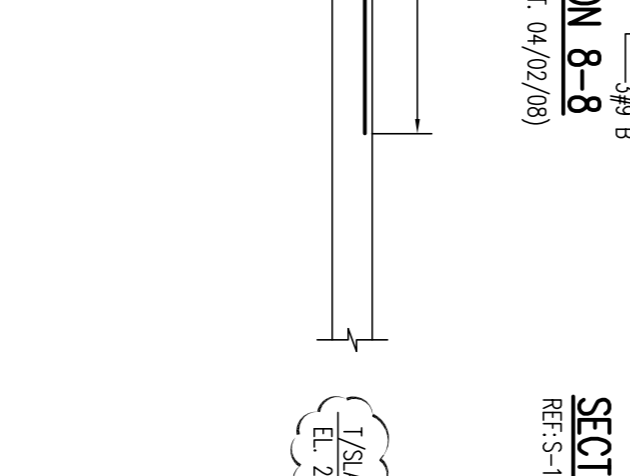
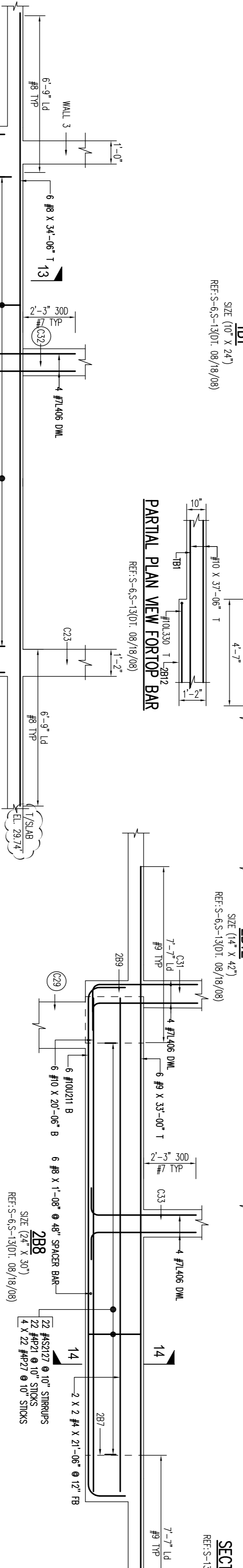
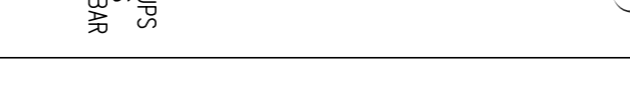
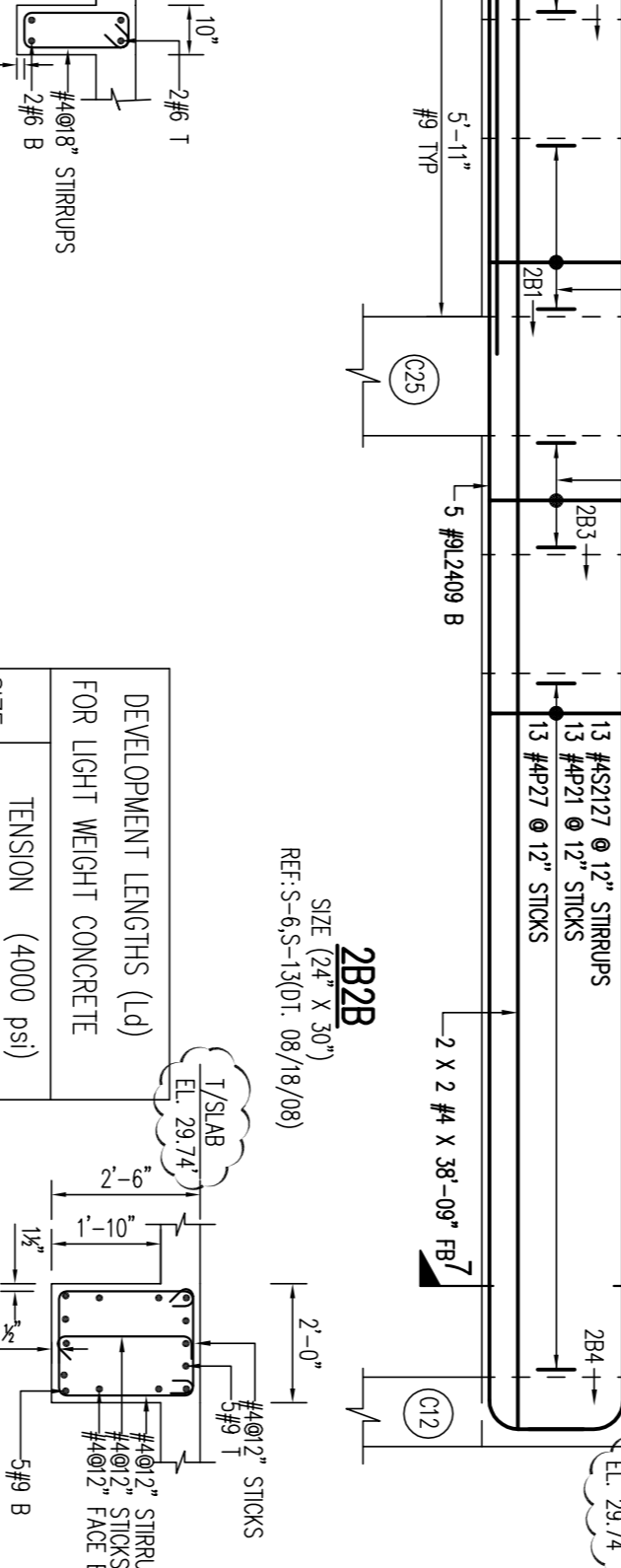
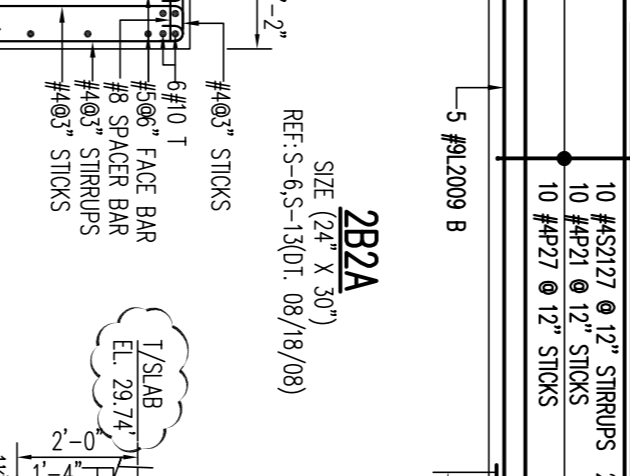
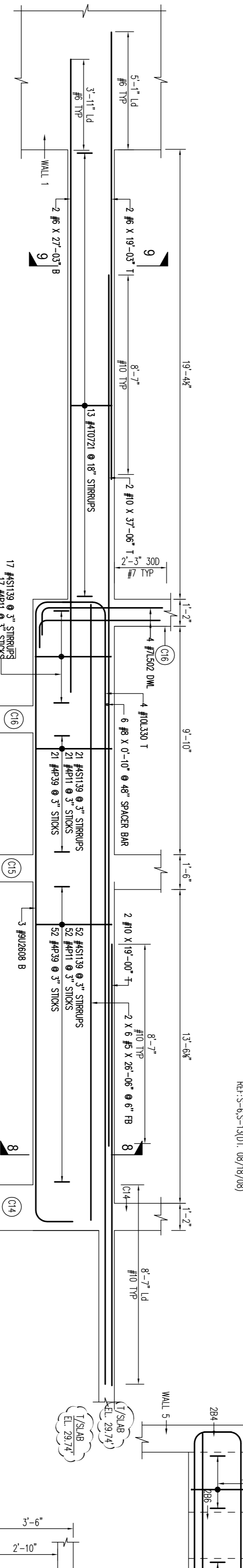
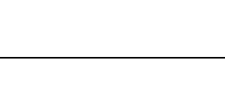
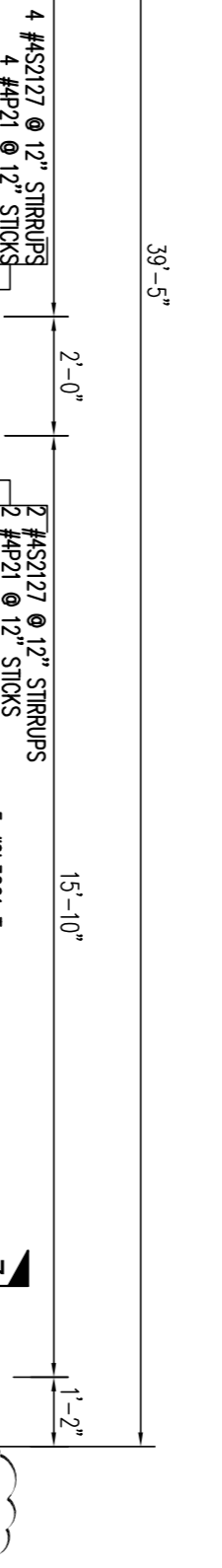
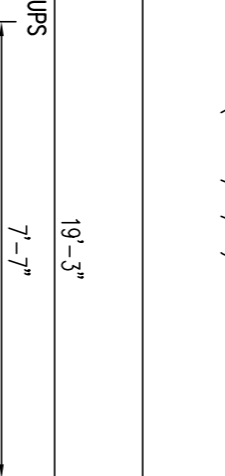
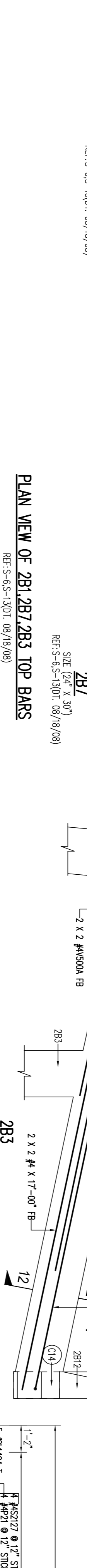

- NOTES**
- TYPICAL CLEARANCES.
  - FOR BEAMS COVER AT ALL SIDES = 1.5"
  - FOR BEAMS END COVER = 2 1/2"
  - AT INTERSECTION = 3 1/2"
  - BAR TO BE PLACED AT EQUAL SPACING U.O.N
  - A/E PLEASE VERIFY CLOUDED ITEMS.
  - A/E PLEASE VERIFY THE TOP OF SLAB ELEVATION

| SIZE | TENSION | (4000 PSI) |
|------|---------|------------|
| #3   | 2'-0"   | 2'-7"      |
| #4   | 2'-8"   | 3'-5"      |
| #5   | 3'-3"   | 4'-3"      |
| #6   | 3'-11"  | 5'-1"      |
| #7   | 4'-7"   | 5'-11"     |
| #8   | 5'-3"   | 6'-9"      |
| #9   | 5'-11"  | 7'-7"      |
| #10  | 6'-8"   | 8'-7"      |
| #11  | 9'-6"   | 11'-10"    |

**LEGEND**

- B = SECTION MARK
- = BOTTOM
- = DOWL
- EL. = ELEVATION
- TYP = TYPICAL
- U.O.N = UNLESS OTHERWISE NOTED
- REF = REFERENCE
- FB = FACE BAR